



晏杰光电
MAJOR LIGHTING

MJ-F2835L80WX-X-HE

SPECIFICATION SHEET

2019.04 V-1.0

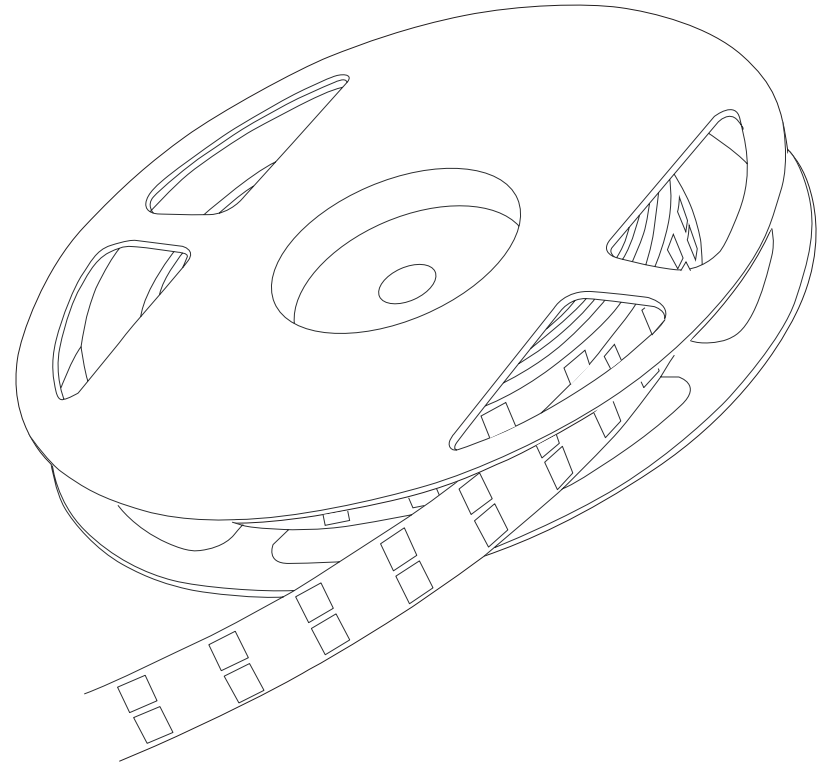

MJ-F2835L80WX-X-HE

Comprehensive Description

Applying to BLIGHT, decorative lighting, LED Strip has the features of long lifetime and small brightness decay.

Various color temperature are available and only ONE BIN is used for each order to keep same color.

Material and technology:

- ◆ LED is packaged with pure gold thread and large chip;
- ◆ Lead-free SMT(RoHS), welding spot is rounded and strong;
- ◆ Double layer PCB to ensure stable electrical property;
- ◆ Authentic 3M adhesive tape with stronger stickiness;
- ◆ A variety of fittings are optional to install easily;
- ◆ Different waterproofing grade: IP65, IP67, IP68 and Nano waterproof;
- ◆ The best silica gel is used to make waterproof;

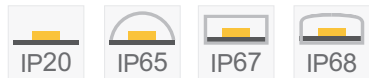

Technical Parameters

Model: MJ-F2835L80WX-X-HE

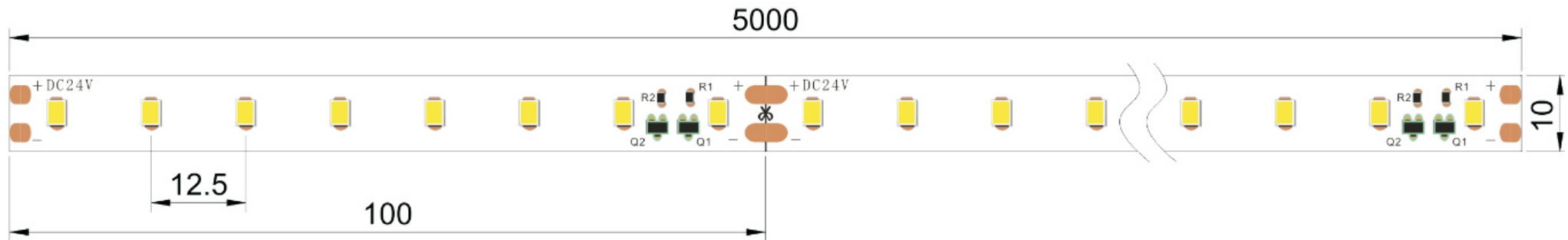

Optical parameters

LED Type	SMD2835
Ra	CRI>80&CRI>90
CCT	2400K/2700K/3000K/4000K/6000K
Emitting Angle	120°
Luminous flux/LED	28-30lm/LED

Electrical parameters

Input Current	0.5A/m
Input Voltage	DC24V
Watt/m	12W/m

Others

Energy Efficiency	A
Warranty	5 years
Operating lifetime	30,000h
Operating temperature	-20°C- +45°C
Operating humidity	40%-70%RH
Waterproof grade	IP20,IP65,IP67,IP68
Dimensions	5000*10mm
LED Qty/m	80LED/m
Min cuttable distance	100mm(8LED)

Test Report

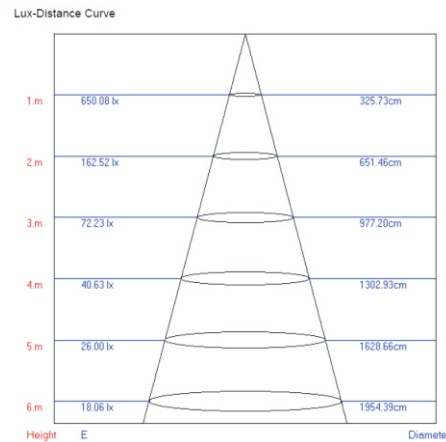
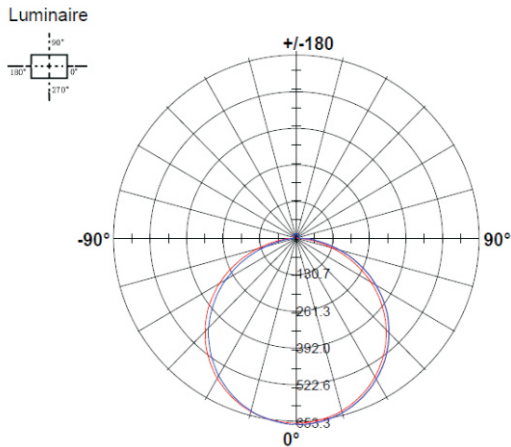
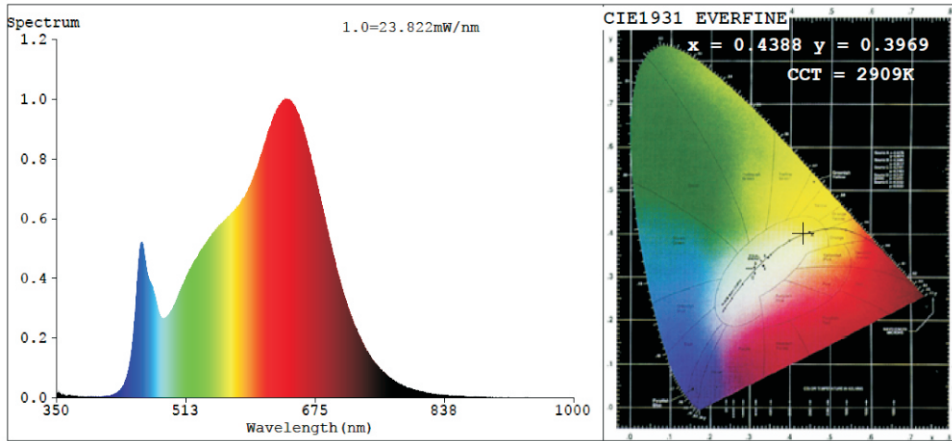

Certifications

Intertek AUTHORIZATION TO MARK

This authorizes the application of the Certification Mark(s) shown below to the models described in the Product(s) Covered section when made in accordance with the conditions set forth in the Certification Agreement and Listing Report. This authorization also applies to multiple later models(s) identified on the correlation page of the Listing Report. This document is the property of Intertek Testing Services and is not transferable. The certification mark(s) may be applied only at the location of the Party Authorized To Apply Mark.

Applicant: Shenzhen Shinesky Optoelectronics Co., LTD
Address: 2F, H1 Building, Hongfa Hi-tech Park, Tangtou, Shiyuan Town, Bao'an District, Shenzhen, Guangdong, China
Contact: Bin Wu
Phone: +86-755-29116235
FAX: +86-755-29116235
Email: hui@shinesky.com

Manufacturer: Shenzhen Shinesky Optoelectronics Co., LTD
Address: 2F, H1 Building, Hongfa Hi-tech Park, Tangtou, Shiyuan Town, Bao'an District, Shenzhen, Guangdong, China
Contact: Bin Wu
Phone: +86-755-29116235
FAX: +86-755-29116235
Email: mai@shinesky.com

Party Authorized To Apply Mark: Intertek Testing Services Shanghai

Control Number: 5000956 **Authorized by:** Thomas J. P. O'Connell, Compliance Manager

Intertek Testing Services NA Inc.
 645 East Argonne Road, Aliso Viejo, CA 92656
 Telephone: 949.346.9851 or 949.434.9867 Fax: 949.286.9722

Standards: General Requirements for Luminaires - CIE S112 No 9.8 (Issued: 1996/06/01 Ed. 1 (2011), with Cor. 1: 1997, Cor. 2: 2000)

Product: Low voltage lighting LED strip

Model: SK-CV102-2 color: "X", "Y" and "Z" is a letter in the combination of a letter and a number

ATM for Report 1530064695NA-001 Page 1 of 1 ATM issued: 21 May 2015

CERTIFICATE of Conformity
 EC Council Directive 2004/108/EC
 Electromagnetic Compatibility

Registration No.: AE 50329836 0001
Report No.: 17055806 001

Holder: Shenzhen Shinesky Optoelectronics Co., LTD
 2F, H1 Building, Hongfa Hi-tech Park, Tangtou, Shiyuan Town, Bao'an District, Shenzhen, City 518108, P.R. China

Product: LED Lamp (LED Strip)

Identification: Type designation: SK-070270 ("x", "y", "z" are variables, refer to report for details)
 Serial No.: n.a.
 Remark: Refer to test report 17055806 001 for details.

Tested acc. to: EN 60529:2012
 EN 61347:2009

This certificate of conformity is based on an evaluation of a sample of the above mentioned product. Technical Report and documentation are at the License Holder's disposal. This is to certify that the tested sample is in conformity with all provisions of Annex 1 of Council Directive 2004/108/EC. This certificate does not imply assessment of the production of the product and does not permit the use of a TÜV Rheinland mark of conformity. The holder of the certificate is authorized to use this certificate in connection with the EC declaration of conformity according to the a.m. Directive.

Date: 15.01.2018
 TÜV Rheinland LGA Products GmbH · Tillystraße 2 · 90431 Nürnberg

CE The CE marking may only be used if all relevant and effective EC Directives are complied with. CE

SGS Test Report No. NLTW4191706171041 Date: FEB 18, 2016 Page 1 of 6

SHENZHEN SHINESKY OPTOELECTRONICS CO., LTD
 2F, H1 BLDG, HONGFA HI-TECH PARK, TANGTOU, SHIYUAN TOWN, BAO'AN DISTRICT, SHENZHEN, P.R. CHINA

This report supplements the previous documents bearing the test report number 705010706171041. The following sample were submitted and identified by test bench #1:

LED STRIP

Serial Reference Information: SEE ATTACHMENT
 Sample Receiving Date: JAN 07, 2016
 Further Information Date: FEB 18, 2016
 Testing Period: JAN 07, 2016 TO JAN 18, 2016

Test Requested	Conclusion
1. European RoHS Directive 2011/65/EU Annex II (excluding 2002/95/EC) (Electronic specimens) were tested as specified by the applicant. (Refer to test bench #1 report for details)	PASS

FOR FURTHER DETAILS, PLEASE REFER TO THE FOLLOWING PAGES:

Signed for and on behalf of SGS-CSTC Shanghai Technical Services Co., Ltd. Shenzhen Branch-Tiny Laboratory

Party Signature, address: Shiyuan Technical Storage

SGS Certificate: CH703036

SHENZHEN SHINESKY OPTOELECTRONICS CO., LTD.
 2F, H1 Building, Tangtou Hi-tech Park, Tangtou, Shiyuan Town, Bao'an District, Shenzhen, Guangdong, P.R. China
 United Social Credit Code: 91440303191881328A

ISO 9001:2015

Design and manufacture of LED strip products

For further information, please refer to the following pages:

1. European RoHS Directive 2011/65/EU Annex II (excluding 2002/95/EC) (Electronic specimens) were tested as specified by the applicant. (Refer to test bench #1 report for details)

2. This certificate is valid from 2 March 2017 until 1 March 2020 and covers only the addition of LED strips to the production units.

3. Recertification audit on 2 March 2017. Issue 1. Certified since 2 March 2017.

SGS LGA Products GmbH · Tillystraße 2 · 90431 Nürnberg

Installation Instructions

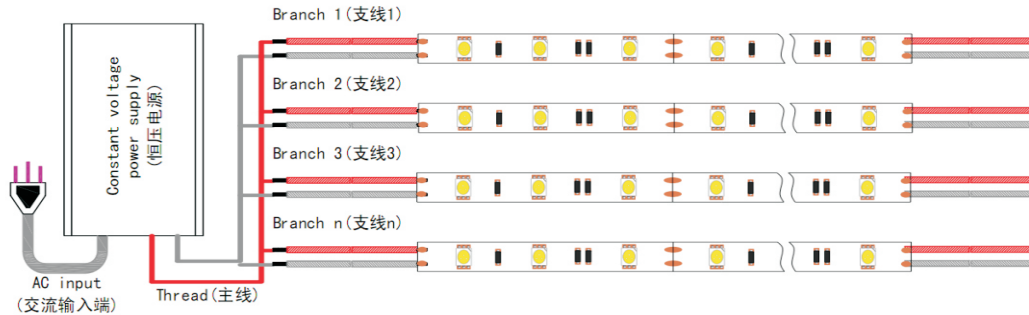

Package

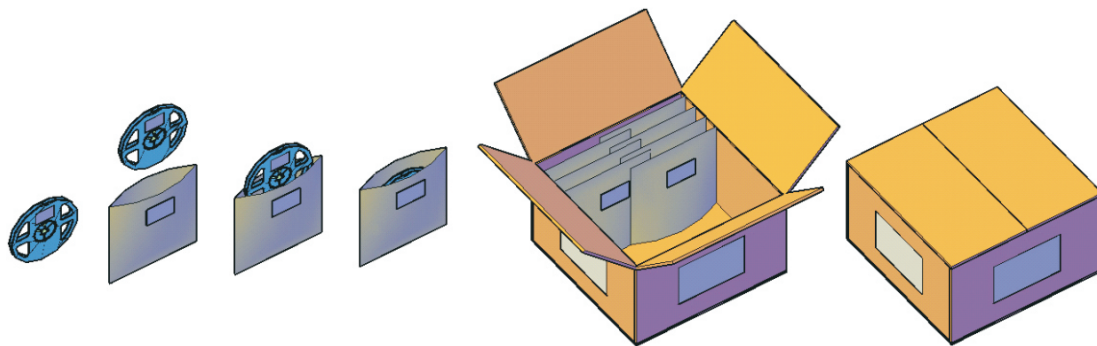

Note:

1. One Aluminum Foil Bag for one roll of LED strip, 5M/roll.
2. All the packaging materials are RoHS standard.
3. Heavy stuff are not allow to be loaded above the packaging box.

⚠ Cautions:

- When install the led strip , please note the installation technique. The led strip can be bent, but not distorted, as shown below:

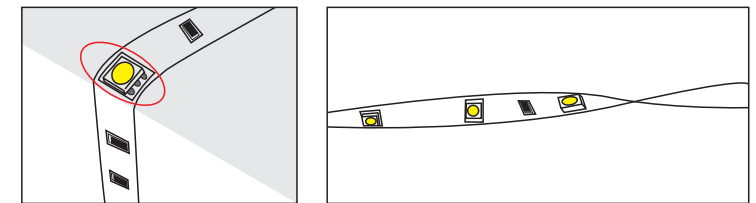
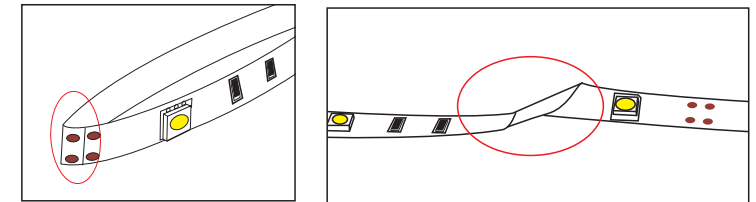

Distortion(Wrong)

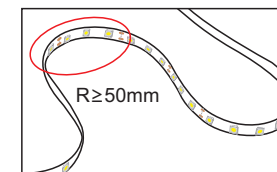

Bend(Right)

- LED strips are low voltage products, you must use the power supply(transformer). Please don't connect the led strip directly to the AC110 or AC220V, otherwise it will burn out the LED strips.
- Clean up the installation surface, it will ensure the reliability of the adhesive.
- The electrical connection process must be operated by a professional person.